

Manual
Knife Mill GM 300



Translation



Copyright

© Copyright by
Retsch GmbH
Haan, Retsch-Allee 1-5
D-42781 Haan
Federal Republic of Germany

1	Notes on the Operating Manual	5
1.1	Explanations of the safety warnings	6
1.2	General safety instructions	7
1.3	Repairs	8
2	Confirmation	9
3	Transport, scope of delivery, installation	10
3.1	Packaging	10
3.2	Transport	10
3.3	Temperature fluctuations and condensed water	10
3.4	Conditions for the place of installation	10
3.5	Removing the transport safeguard	11
3.6	Installation of the machine	11
3.7	Electrical connection	11
3.8	Type plate description	11
4	Technical data	13
4.1	Use of the machine for the intended purpose	13
4.2	Protective equipment	13
4.3	Emissions	14
4.4	Degree of protection	14
4.5	Drive output	15
4.6	Rated power	15
4.7	Rated voltage	15
4.8	Rotation speed	15
4.9	Dimensions and weight	15
4.9.1	Height with Hood Cover Closed	15
4.9.2	Height with Hood Cover Open	15
4.9.3	Weight	15
4.10	Required floor space	15
5	Operating the machine	16
5.1	Views of the Instrument	16
5.2	Operating elements and displays	17
5.3	Overview table of the parts of the device	19
5.4	Switching On and Off	20
5.5	Opening and closing of the grinding chamber	20
5.6	Handling the Knife	20
5.7	Inserting the grinding jar	22
5.7.1	Grinding container - use with different materials	24
5.8	Grinding Jar Lid Sealing Rings	24

5.9	Starting the grinding process	25
5.10	Interrupting and continuing the grinding process	25
5.11	Stopping the grinding process	25
5.12	Menu structure	26
5.12.1	Setting Possibilities on the Display Menu	26
5.13	Setting the grinding time	28
5.14	Setting the Speed	28
5.15	Setting the Direction of Rotation	29
5.16	Setting the interval	29
5.17	Emergency unlocking	29
6	Working instructions	31
7	Fault messages	31
8	Cleaning and service	32
9	Accessories	34
10	Disposal	35
11	Index	36
	Appendix	following pages

1 Notes on the Operating Manual

This operating manual is a technical guide on how to operate the device safely and it contains all the information required for the areas specified in the table of contents. This technical documentation is a reference and instruction manual. The individual chapters are complete in themselves.

Familiarity (of the respective target groups defined according to area) with the relevant chapters is a precondition for the safe and appropriate use of the device.

This operating manual does not contain any repair instructions. If faults arise or repairs are necessary, please contact your supplier or get in touch with Retsch GmbH directly.

Application technology information relating to samples to be processed is not included but can be read on the Internet on the respective device's page at www.retsch.com.

Changes

Subject to technical changes.

Copyright

Disclosure or reproduction of this documentation, use and disclosure of its contents are only permitted with the express permission of Retsch GmbH.

Infringements will result in damage compensation liability.

1.1 Explanations of the safety warnings

In this Operating Manual we give you the following safety warnings

Serious injury may result from failing to heed these safety warnings. We give you the following warnings and corresponding content.

 **WARNING**

Type of danger / personal injury

Source of danger

- Possible consequences if the dangers are not observed.
 - **Instructions on how the dangers are to be avoided.**
-

We also use the following signal word box in the text or in the instructions on action to be taken:

 **WARNING**

Moderate or mild injury may result from failing to heed these safety warnings. We give you the following warnings and corresponding content.

 **CAUTION**

Type of danger / personal injury

Source of danger

- Possible consequences if the dangers are not observed.
 - **Instructions on how the dangers are to be avoided.**
-

We also use the following signal word box in the text or in the instructions on action to be taken:

 **CAUTION**

In the event of possible **property damage** we inform you with the word “Instructions” and the corresponding content.

NOTICE

Nature of the property damage

Source of property damage

- Possible consequences if the instructions are not observed.
 - **Instructions on how the dangers are to be avoided.**
-

We also use the following signal word in the text or in the instructions on action to be taken:

NOTICE

1.2 General safety instructions

 **CAUTION**

Read the Operating Manual

Non-observance of these operating instructions

- The non-observance of these operating instructions can result in personal injuries.
- **Read the operating manual before using the device.**
- **We use the adjacent symbol to draw attention to the necessity of knowing the contents of this operating manual.**



Target group : All persons concerned with the machine in any form

This machine is a modern, high performance product from Retsch GmbH and complies with the state of the art. Operational safety is given if the machine is handled for the intended purpose and attention is given to this technical documentation.

You, as the owner/managing operator of the machine, must ensure that the people entrusted with working on the machine:

- have noted and understood all the regulations regarding safety,
- are familiar before starting work with all the operating instructions and specifications for the target group relevant for them,
- have easy access always to the technical documentation for this machine,
- and that new personnel before starting work on the machine are familiarised with the safe handling of the machine and its use for its intended purpose, either by verbal instructions from a competent person and/or by means of this technical documentation.

Improper operation can result in personal injuries and material damage. You are responsible for your own safety and that of your employees.

Make sure that no unauthorised person has access to the machine.

 **CAUTION**

Changes to the machine

- Changes to the machine may lead to personal injury.
- **Do not make any change to the machine and use spare parts and accessories that have been approved by Retsch exclusively.**

NOTICE

Changes to the machine

- The conformity declared by Retsch with the European Directives will lose its validity.
- You lose all warranty claims.
- **Do not make any change to the machine and use spare parts and accessories that have been approved by Retsch exclusively.**

1.3 Repairs

This operating manual does not contain any repair instructions. For your own safety, repairs may only be carried out by Retsch GmbH or an authorized representative or by Retsch service engineers.

In that case please inform:

The Retsch representative in your country
Your supplier
Retsch GmbH directly

Your Service Address:

2 Confirmation

This operating manual contains essential instructions for operating and maintaining the device which must be strictly observed. It is essential that they be read by the operator and by the qualified staff responsible for the device before the device is commissioned. This operating manual must be available and accessible at the place of use at all times.

The user of the device herewith confirms to the managing operator (owner) that (s)he has received sufficient instructions about the operation and maintenance of the system. The user has received the operating manual, has read and taken note of its contents and consequently has all the information required for safe operation and is sufficiently familiar with the device.

As the owner/managing operator you should for your own protection have your employees confirm that they have received the instructions about the operation of the machine.

I have read and taken note of the contents of all chapters in this operating manual as well as all safety instructions and warnings.

User

Surname, first name (block letters)

Position in the company

Signature

Service technician or operator

Surname, first name (block letters)

Position in the company

Place, date and signature

3 Transport, scope of delivery, installation

3.1 Packaging

The packaging has been adapted to the mode of transport. It complies with the generally applicable packaging guidelines.

NOTICE

Storage of packaging

- In the event of a complaint or return, your warranty claims may be endangered if the packaging is inadequate or the machine has not been secured correctly.
 - **Please keep the packaging for the duration of the warranty period.**
-

3.2 Transport

NOTICE

Transport

- Mechanical or electronic components may be damaged.
 - **The machine may not be knocked, shaken or thrown during transport.**
-

3.3 Temperature fluctuations and condensed water

NOTICE

Temperature fluctuations

The machine may be subject to strong temperature fluctuations during transport (e.g. aircraft transport)

- The resultant condensed water may damage electronic components.
 - **Protect the machine from condensed water.**
-

3.4 Conditions for the place of installation

NOTICE

Ambient temperature

- Electronic and mechanical components may be damaged and the performance data alter to an unknown extent.
 - **Do not exceed or fall below the permitted temperature range of the machine (5°C to 40°C / ambient temperature).**
-

Atmospheric humidity:

Maximum relative humidity 80% at temperatures up to 31°C, decreasing linearly up to 50% relative humidity at 40°C

NOTICE

Atmospheric humidity

- Electronic and mechanical components may be damaged and the performance data alter to an unknown extent.
- **Do not exceed the admissible range for atmospheric humidity.**

3.5 Removing the transport safeguard

Remove the cardboard cross, which serves to protect the knives during transport), from the inside of the grinding jar.

3.6 Installation of the machine

Installation height: maximum 2000 m above sea level

NOTICE

Installation of the machine

- It must be possible to disconnect the machine from the mains at any time.
- **Install the machine such that the connection for the mains cable is easily accessible.**

3.7 Electrical connection

 **WARNING**

When connecting the power cable to the mains supply, use an external fuse that complies with the regulations applicable to the place of installation .

- Please check the type plate for details on the necessary voltage and frequency for the device.
- Make sure the levels agree with the existing mains power supply.
- Use the supplied connection cable to connect the device to the mains power supply.

3.8 Type plate description

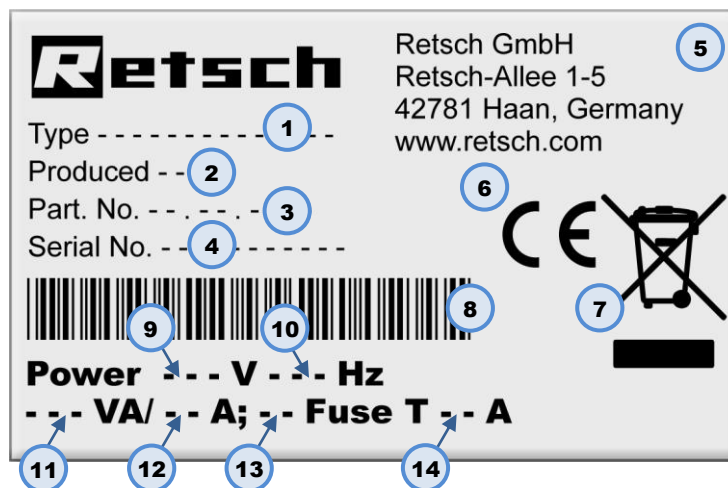

Fig. 1: Type plate lettering

- 1 Device designation
- 2 Year of production
- 3 Part number
- 4 Serial number
- 5 Manufacturer's address
- 6 CE marking
- 7 Disposal label
- 8 Bar code
- 9 Power version
- 10 Mains frequency
- 11 Capacity
- 12 Amperage
- 13 Number of fuses
- 14 Fuse type and fuse strength

In the case of questions please provide the device designation (1) or the part number (3) and the serial number (4) of the device.

4 Technical data

4.1 Use of the machine for the intended purpose

Target group: Operators

Machine type designation: GM 300

The GRINDOMIX GM 300 laboratory knife mill serves to mill, homogenise and mix

soft to medium-hard, aqueous, fatty, fibrous and dry materials within seconds

so that they will be suitable for analysis.

It can process sample volumes of up to 4.5 litres quickly and reproducibly.

The GRINDOMIX GM 300 is designed for quantities up to approx. 4500 ml, large volume materials up to 1000 ml. The feed size is < 130 mm.

It is particularly engineered to cut up the following materials:

fish, meat, vegetables, cheese, fodder pellets, seeds, bacon, sausage, dry bakery products and pasta, all products with high water, fat and fibrous content and similar materials.

The GRINDOMIX GM 300 meets the special laboratory and analysis requirements and in its range of performance it far outstrips that of commercially available household mixers.

Our applications laboratory will be happy to give you more information.

- Fast and gentle size reduction and homogenisation of food
- Speed selectable from 500 - 4,000 rpm
- Powerful 1.5 KW industrial motor
- All parts which come in contact with the sample material are autoclaveable
- Easy changing and cleaning of the grinding tools
- Interval operation and reverse mode possible
- Mode for preliminary size reduction and fine size reduction
- Digital parameter preselection
- 10 parameter combinations can be stored

NOTICE

Area of use of the machine

- This machine is a laboratory machine designed for 8-hour single-shift operation.
 - **This machine may not be used as a production machine nor is it intended for continuous operation.**
-

4.2 Protective equipment

Manual access into the GRINDOMIX GM300 grinding chamber is prevented by an electromechanical locking device.

The device can be started only if the housing cover is closed and can be opened only if the motor has stopped completely.

The actual speed is displayed during operation.

The safety device checks that the grinding jar and cover are in place before the grinding process can be started.

If the speed deviates by more than 15 %, the device will switch off automatically.

4.3 Emissions

 **CAUTION**

Damage to hearing

The level of noise can be high depending on the type of material, the knife used, the speed set and the duration of the grinding process.

- Noise that is excessive in terms of level and duration can cause impaired or permanently damaged hearing.

- **Ensure suitable sound-proofing measures or wear hearing protection.**



 **CAUTION**

Possibility of acoustic signals not being heard

Loud grinding noises

- Acoustic alarms and voice communication might not be heard.

- **Consider the volume of the grinding noise in relation to other acoustic signals in the work environment. You may wish to use additional visual signals.**

Noise characteristics:

The noise is measured in conformance to DIN 45635-031-01-KL3.

The noise characteristics are influenced by the properties of the material being ground.

Example 1):

Sound-power level LWA = 93.5 dB (A)

Workplace-related emissions level Lp Aeq = 78.7 dB (A)

Operating conditions:

Container = plastic container with cover

Grinding organ = stainless steel knives

Feed material = quartz sand

Feed volume = 2.5 l

Speed = 3000 min⁻¹

4.4 Degree of protection

Grinding chamber and keyboard IP45

In the area of the ventilation slots IP20

4.5 Drive output

3-phase asynchronous motor with frequency converter

4.6 Rated power

Continuous duty 1.5 KW, peak performance 3 kW

4.7 Rated voltage

– 220 - 230 V → 50 / 60Hz ± 0,1Hz

4.8 Rotation speed

The knife speed can be set in 100-rpm steps from 500 to 4000 rpm.

4.9 Dimensions and weight**4.9.1 Height with Hood Cover Closed**

Height: 340 mm

Width: 440 mm

Depth: 440 mm

4.9.2 Height with Hood Cover Open

Height: 700 mm

Width: 440 mm

Depth: 430 mm

4.9.3 Weight

approx. 30 kg

4.10 Required floor space

440 mm x 440 mm; no safety margins required

5 Operating the machine

5.1 Views of the Instrument

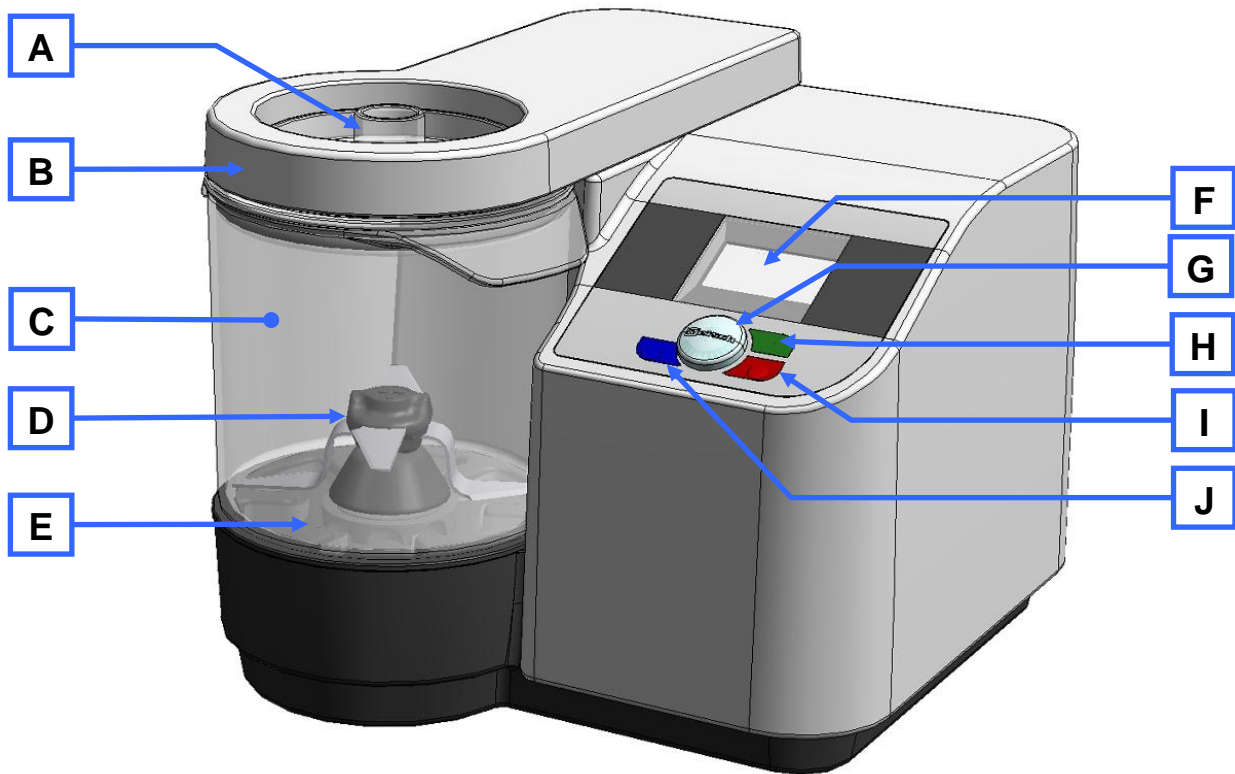

Fig. 2: Front view

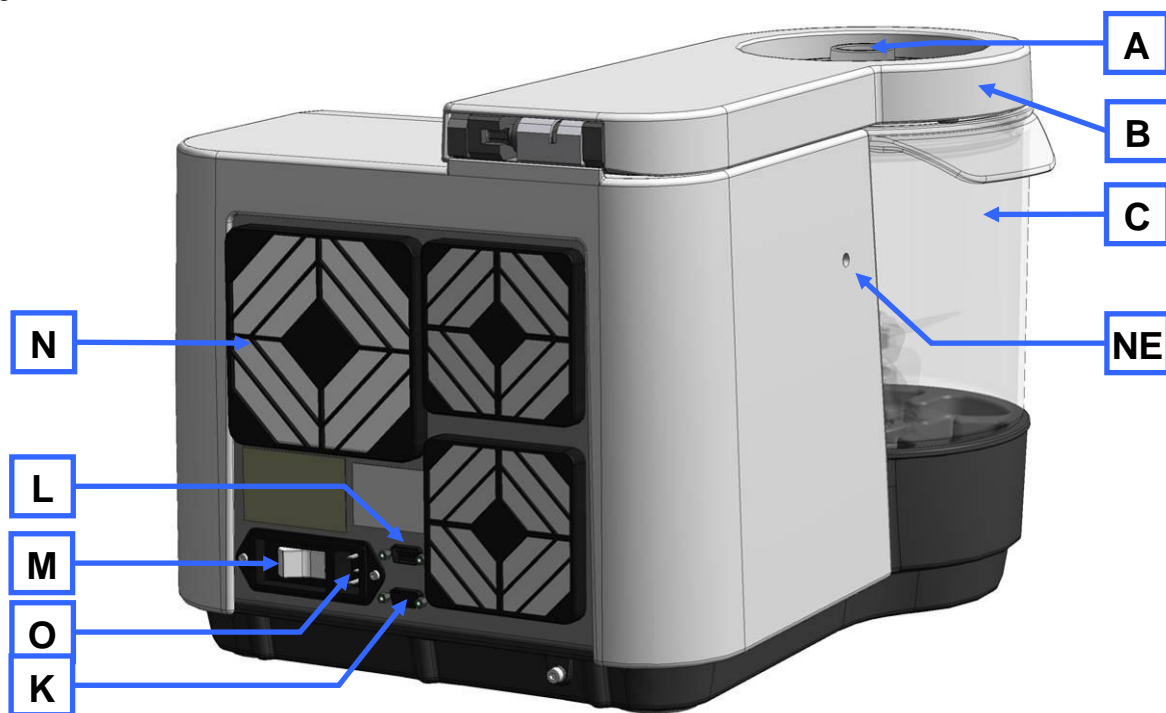

Fig. 3: Rear view



Fig. 4: Detailed views of housing

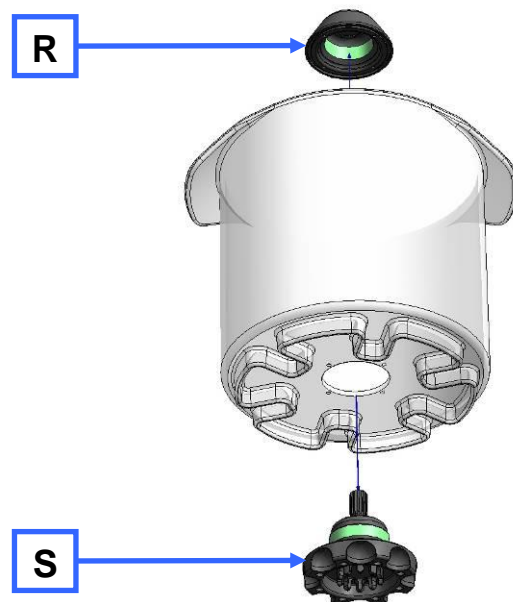

Fig. 5: Detail of grinding jar disassembly

5.2 Operating elements and displays

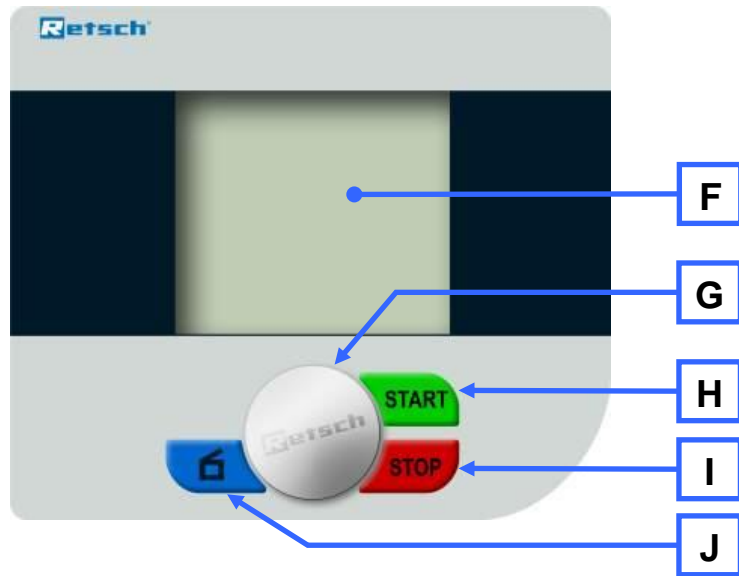

Fig. 6: Graphical View of the Control Panel

5.3 Overview table of the parts of the device

Element	Description	Function
A	Grinding jar cover	Closes the grinding chamber
B	Flap	Prevents interference with the grinding chamber
C	Grinding chamber	Accommodates the sample material
D	Knife	Grinds the sample material
E	Jar holder (base frame)	Accommodates the grinding jar
F	Display window	To check settings and operating conditions
G	Control knob	To adjust the device
H	START button	To start the grinding process
I	STOP button	To stop the grinding process
J	Button to open the flap	Releases the flap lock
K	Not assigned	No function
L	Serial port	Software update and service
M	On/off button	Disconnects device from the power supply
N	Housing fan	Cools the drive
O	Electrical connection	IEC connector
P	Tightening	Is held by the electromechanical interlock
Q	Seal of tightening	Prevents penetration of dirt
R	Cone dome	Seals the knife bearing
S	Bearing flange	Supports the knife shaft
W	Coupler	Connects bearing flange and drive
X	Centring ring	Guides the coupler

5.4 Switching On and Off

- Switch on the mill by pressing the ON/OFF switch (**M**) at the back.

When the GM300 is switched on for the first time, the language menu is displayed.

You can select your national language here by turning the operating knob (**G**). Pressing this knob confirms the selection and the display shows “Open Lid”.

5.5 Opening and closing of the grinding chamber

- Press the (J) key. 

The electromagnetic safety interlock opens and the flap can be folded back. The grinding jar is now freely accessible.

NOTE

After the interruption or end of a grinding process, the flap must be opened once.

Closing the grinding chamber is only possible if the GM300 is connected to the power supply and the main switch on the back of the device is switched on.

- Shut the housing lid (**B**) and press it downwards until the lid closure is activated .

A sensor detects the closure of the housing lid and the motor-driven lid closure is switched on. The housing lid is closed automatically.

5.6 Handling the Knife



Injuries in the form of cuts

Sharp knife blades

- The knife blades are very sharp and if handled incorrectly, they can lead to injuries in the form of cuts.
- **Touch the knife only at the recessed grips.**
- **Do not reach into the grinding jar as long as sample material is covering the knife.**
- **Only reach into the grinding jar if it is outside the mill.**
- **Before taking out the knife, remove the sample material until the recessed grips are free. Use a scraper or shake off the material.**

NOTE

Insert the knife before feeding the material to be ground; otherwise, the material to be cut up can settle between the knife and the driving shaft.

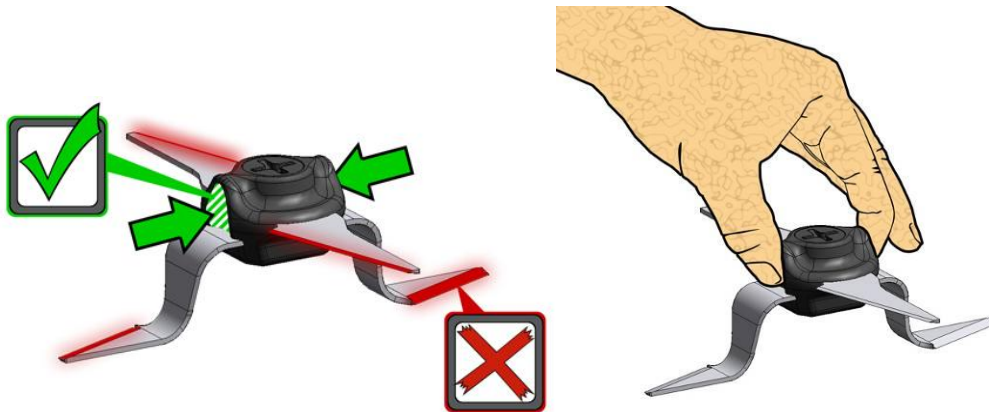

Fig. 7: Recessed grips on the knife

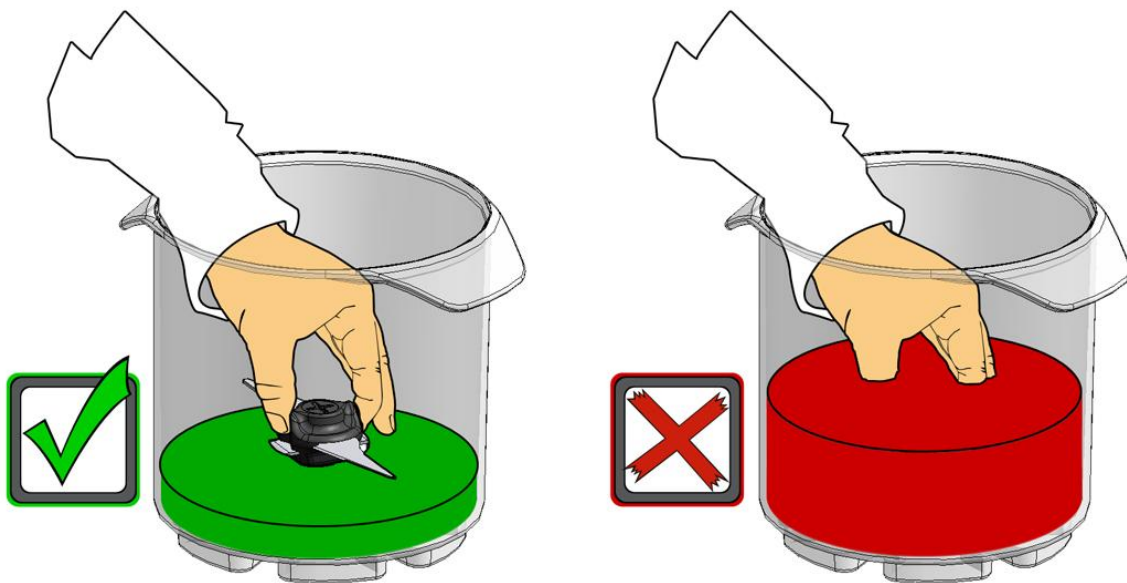

Fig. 8: Removing the knife– Fill level of the grinding jar

Note that the knife must be inserted before filling the grinding jar. The knife is placed on the shaft and held by magnetic force .

The sealing lip (**DL**) of the V ring seal (**V**) must point downwards when inserted. (See Fig. for knife assembly)

NOTICE

- Remove the knife after the grinding process.
- Do not leave the knife in the sample material!
- Clean the knife after grinding and then dry carefully.

CAUTION

If the bottom, bent blade of the knife is so deformed that it touches the inside of the jar it must be replaced immediately.

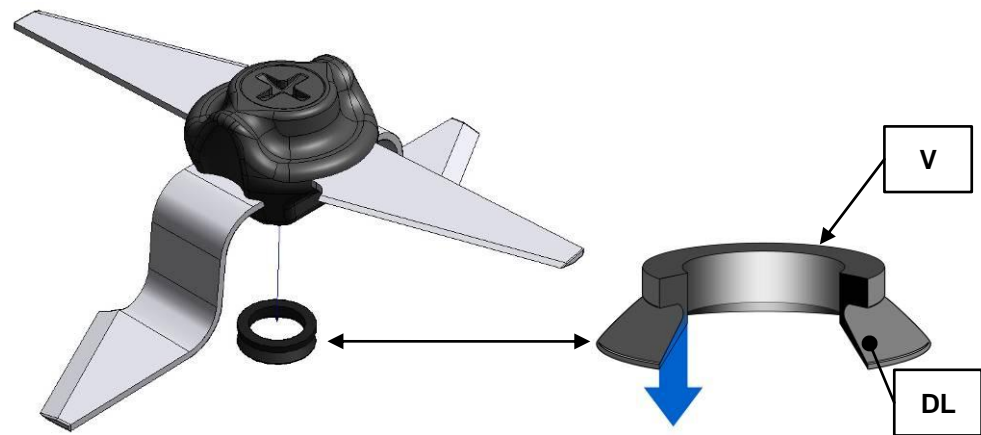

Fig. 9: Inserting the sealing ring

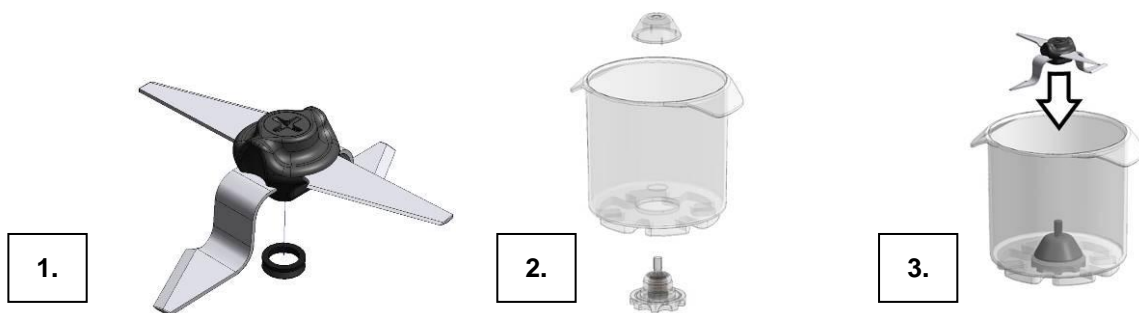

Fig. 10: Preparing the knife and grinding jar, inserting the knife

NOTE

- Check the state of the V-ring seal (**V**) regularly.
- The bottom edge of the lip seal (**DL**) must be clean and smooth.
- Replace the V-ring seal when the lip seal is brittle, cracked, frayed or damaged in order to prevent rust and damage to the cutter bearing.

(V-ring seal part number: **05.111.0243**)

5.7 Inserting the grinding jar

CAUTION

When grinding with dry ice(CO₂), give consideration to the quantity of dry ice used and the volume of gas that will develop accordingly.

The grinding jar lids have varying ventilation characteristics and can be pressed upwards by the large volume of the generated gas.

CAUTION

Scalding/burns
Hot grinding jar

- Depending on the grinding process, the material being ground and accordingly the grinding jar can become very hot.
- **Wear appropriate protection always when touching the grinding jar if it is hot.**

1. Assemble the knife.

2. Use the face spanner (**SL**) to mount the knife dome and the bearing flange in the grinding jar. (see diagram below)

NOTE

Before inserting the grinding jar, it is essential to ensure that the bearing flange and the knife dome are positioned securely. If necessary, tighten the bearing flange with the face spanner (**SL**).

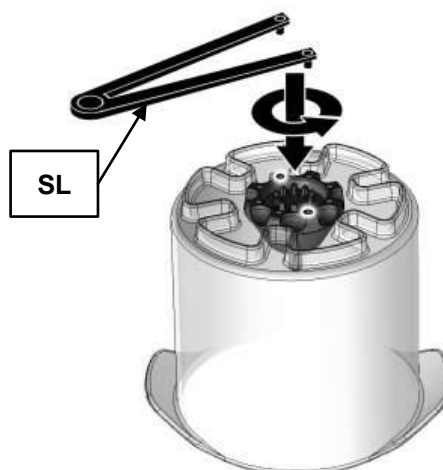

Fig. 11: Use a face spanner to remove the knife dome

3. Put the knife in the grinding jar on the knife dome and let the knife lock into place.
4. Fill the grinding jar with the sample to be ground. Depending on the material, the filling level may be as high as up to 2 cm under the edge of jar.

CAUTION

Note that some materials may increase knife wear, damage the knife or damage the jar.

The knife must not be reground.

CAUTION

If the sample to be ground is dry, use a steel grinding jar. Dry grinding stock can become very hot and damage the PVC grinding jar.

5. Put the lid onto the grinding jar, with one or two sealing rings depending on the material.
6. Insert the grinding jar with knife, grinding stock and lid into the device.
7. Close the flap on the device.
8. Make sure the grinding jar engages with the correspondingly shaped projections.

NOTE

Protect the grinding jar from continuous exposure to sunlight or UV irradiation. The PC jar is not infinitely UV-resistant.

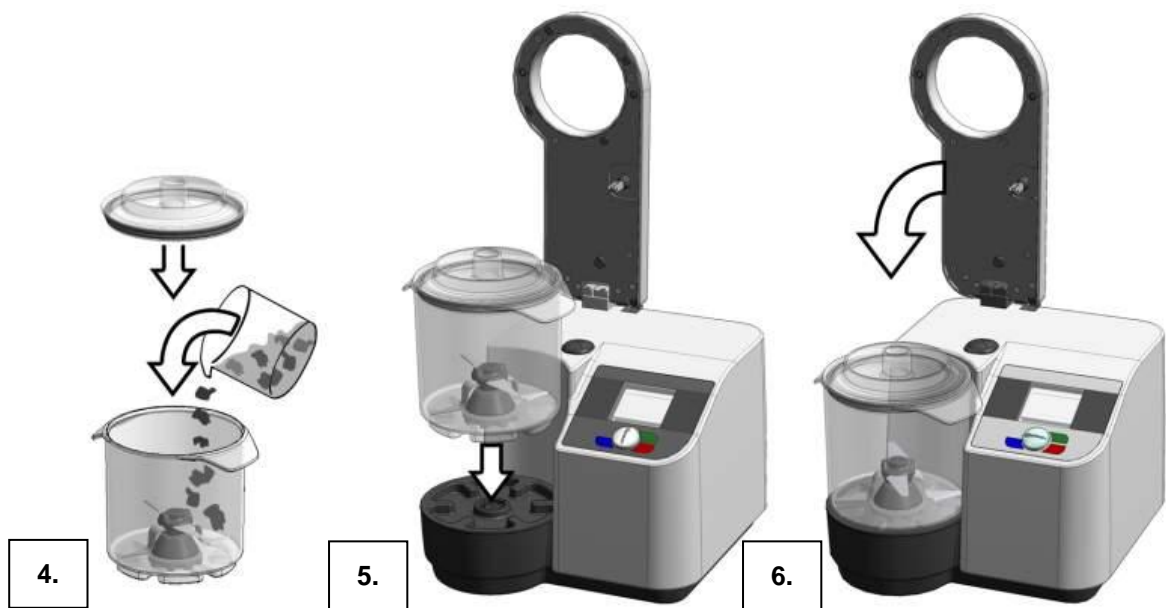

Fig. 12: Inserting the grinding jar and closing the device.

5.7.1 Grinding container - use with different materials

The material properties specified refer to samples from the main area of applications: food or animal fodder

The **plastic** grinding jar is **less** suitable for dry, tough or fibrous samples. **Stainless steel** is recommended for these samples as well as all others from the specified field of applications.

5.8 Grinding Jar Lid Sealing Rings

The grinding jar cover is supplied as standard with a sealing ring inserted in the upper groove.

When grinding dusty or very watery sample material, you can insert the second supplied sealing ring into the grinding jar cover. This prevents sample material escaping.

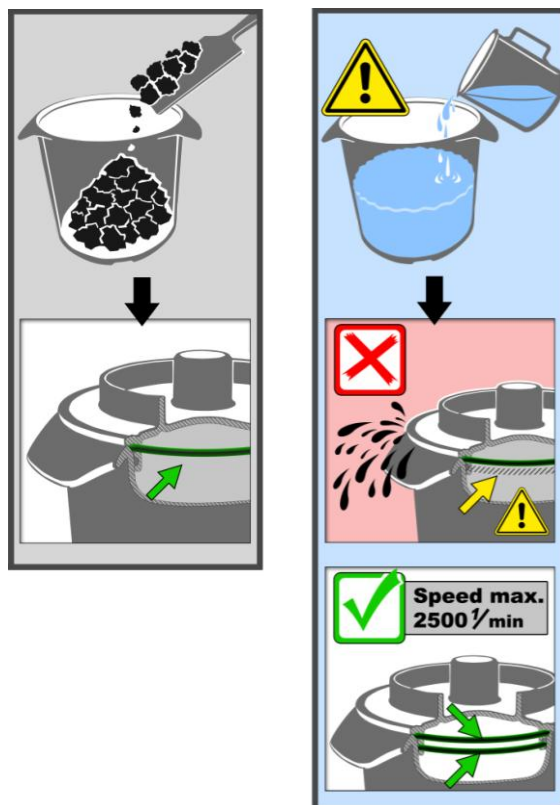

Fig. 13: Use of one or two sealing rings

NOTE

Thin fluid samples should be started at a low speed. Increase the speed gradually. The maximum speed for liquid samples may not exceed 2,500 revolutions per minute.

5.9 Starting the grinding process

- Set the grinding parameters you wish to have.
- Insert the grinding jar with the material to be ground, the knife and the lid.
- Close the flap until the electromechanical safety interlock is closed.
- Press the START (H) key.

5.10 Interrupting and continuing the grinding process

- Press the STOP (I) key.
The grinding process is interrupted or stopped.

5.11 Stopping the grinding process

Interrupting the Grinding Process (Pause)

- Press the STOP key (I) once.
The grinding process is interrupted.

Stopping the Grinding Process (End)

- Press the STOP key (I) twice.
The grinding process is stopped (end).
The grinding parameters are reset to the previously set or stored values.

5.12 Menu structure

This device offers new, very user-friendly prompting. All relevant data can be entered into or called up on a graphic display with one-button operation. The menu instructions are multi-lingual.

5.12.1 Setting Possibilities on the Display Menu

Please refer also to the chapter on menu structure for information on using the setting possibilities on the display, as described in the following.
The selection bar in the display is operated as follows:

Turning function I)

- Turn the setting knob to reach the individual menu items. The selected menu items are marked by the dark selection bar.

Turning function II)

- Turn the setting knob to alter the numbers and decisions in the menu items.

Pressing I)





- Press the setting knob to open the selected menu items.

Pressing II)

- Press the setting knob to confirm the settings.

Pressing III)

- Press and hold the setting knob to return to the start screen (Level 1).

	Direction of rotation (knife beating)
	Direction of rotation (knife cutting)
	Acoustic alarm on
	Acoustic alarm off
	Service required

	1st level	2nd level	3rd level	4th level	5th level	6th level	
1	Manual operation	(Press knob and turn to the left) (Turn knob to the right)					
	Sequences 01 to 10						
	Grinding program 01 to 10						
2	Grinding duration	Grinding duration [1sec. to 3 minutes (m:ss)]					
3	Speed	500 to 4000 revolutions per minute					
	Direction of rotation	Right / left					
4	Interval	Interval grinding duration mm:ss					
		Reverse direction of rotation					
		Set interval mm:ss Back					
6	Program mode	Use parameter Change program Delete program Back					
7	Menu	Settings	Automatic opening	On / off			
			Warning tone	On / off			
			Service	Operating hours	Total operating hours xxxxx.xx.xx hh:mm:ss		
				Operating software	Operating software Version: xyz Update Yes/cancel	Start software update? Yes/cancel	
				Back			
				Back			
			Display	Contrast	Adjust		
				Brightness	Adjust		
				Language	Select		
				Back			
			Date	01.04.03	Set		
			Time	12:05:00	Set		
			Back				

P01	Sequences 01		P01
P01+P02	Sequences 02		P02
P01+P02+P03	Sequences 03		P03
P01+P02+P03+P04	Sequences 04		P04
P01+P02+P03+P04+P05	Sequences 05		P05
P01+P02+P03+P04+P05+P06	Sequences 06		P06
P01+P02+P03+P04+P05+P06+P07	Sequences 07		P07
P01+P02+P03+P04+P05+P06+P07+P08	Sequences 08		P08
P01+P02+P03+P04+P05+P06+P07+P08+P09	Sequences 09		P09
P01+P02+P03+P04+P05+P06+P07+P08+P09+P10	Sequences 10		P10

5.13 Setting the grinding time

- Turn the rotary knob until you reach the grinding time menu item.
The selected menu item is marked by the dark selection bar.
- 1. Press the rotary knob to set the minutes.
- Turn the rotary knob until you reach the desired grinding time in minutes.
- 2. Press the rotary knob to set the seconds.
- Turn the rotary knob until you reach the desired grinding time in seconds.
- 3. Press the rotary knob in order to return to the main menu.

5.14 Setting the Speed

- Turn the rotary knob until you reach the speed menu item.
The selected menu item is highlighted by the dark selection bar.
- 1. Press the rotary knob to set the knife speed.
- Turn the rotary knob until the desired speed (revolutions per minute) is reached.
- 2. Press the rotary knob to return to the main menu.

NOTE

Start runny liquid samples at a low speed. Increase the speed gradually. The maximum speed for liquid samples is just 2,500 revolutions per minute.



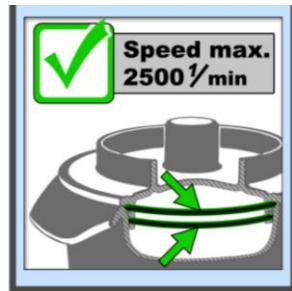

Fig. 14: Maximum speed for runny liquid samples

5.15 Setting the Direction of Rotation

- Turn the rotary knob to reach the direction of rotation menu item. The selected menu item is highlighted by the dark selection bar.
- 1. Press the rotary knob to set the direction of rotation.
- Turn the rotary knob until you reach the desired direction of rotation.

	Direction of rotation (knife beating)
	Direction of rotation (knife cutting)

- 2. Press the rotary knob to return to the main menu.

5.16 Setting the interval

- Turn the rotary knob to reach the interval menu item. The selected menu item is marked by the dark selection bar.
- 1. Press the rotary knob to set the interval time in minutes.
- Turn the rotary knob to reach the desired interval time in minutes.
- 2. Press the rotary knob to set the seconds.
- Turn the rotary knob to reach the desired interval time in seconds.
- 3. Press the rotary knob to set the reversal of the direction of rotation.
- Turn the rotary knob to turn the reversal of direction of rotation ON or OFF.
- 4./5. Press the rotary knob twice to set the interval pause - minute.
- Turn the rotary knob to reach the desired minutes.
- 6. Press the rotary knob to set the interval pause in seconds.
- Turn the rotary knob to reach the desired seconds.
- 3. Press the rotary knob to return to the main menu.

5.17 Emergency unlocking

CAUTION

Emergency Unlocking

Drive continuing to run

- There is a substantial risk of injury if the drive and associated device parts run on a long time without being braked!
- **Activate the emergency unlocking only when the machine has come to a complete stop and is disconnected from the power supply.**



Fig. 15: View of the back

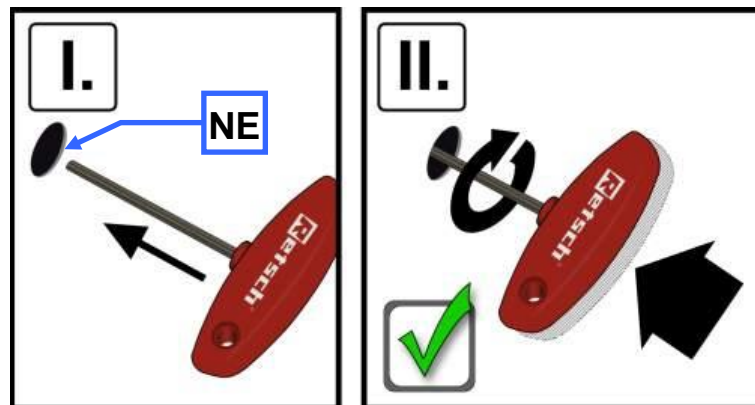

Fig. 16: Emergency unlocking of flap

The GM300 can be opened manually during a power failure.

- Use a slotted screwdriver and lever the plastic plug off over the opening (NE).
- (I.) Put the key into the left side opening (NE).

To unlock the closure gear, the key must be pushed in further with some degree of force.

- (II.) While pushing the key in, turn it in a clockwise direction as far as it will go.

The lid can be opened now.

- Use the plastic plug to close the side opening again.

6 Working instructions

Four sharp, sturdy blades rotate in the centre of the grinding container. Depending on the direction of rotation, cutting is done with the blunt side (preliminary size reduction) or with the sharp side (fine size reduction). To protect the knife from damage from hard material, the knife are equipped with a counterblade.

The powerful industrial motor with 1500 watts in continuous duty or 3000 watts in brief peak performance drives the knife indirectly. Preprogrammable speeds that are electronically maintained at a constant level allow a high level of reproducibility.

7 Fault messages

F01	Overload	
F03	Problem in the safety circuit for the lid lock	Service required!
F04	Lid opening or closing. Otherwise lid lock is defective.	Service required!
F07	Motor control is defective	Service required!
F08	Please enter grinding time	
F09	Housing fan not working.	Service required!
F14	Speed sensor defective.	Service required!
F15	Problem in the safety circuit for the frequency converter	Service required!
F16	Motor is overheated. Can't start.	Let the motor cool down.
F17	Motor switched off due to overheating. Press stop.	Let the motor cool down.
F18	Problem in the safety circuit for the transformer	Service required!
F19	Knife not rotating.	Service required!
F26	Frequency converter is overheated. Can't start.	Let the frequency converter cool down.

8 Cleaning and service

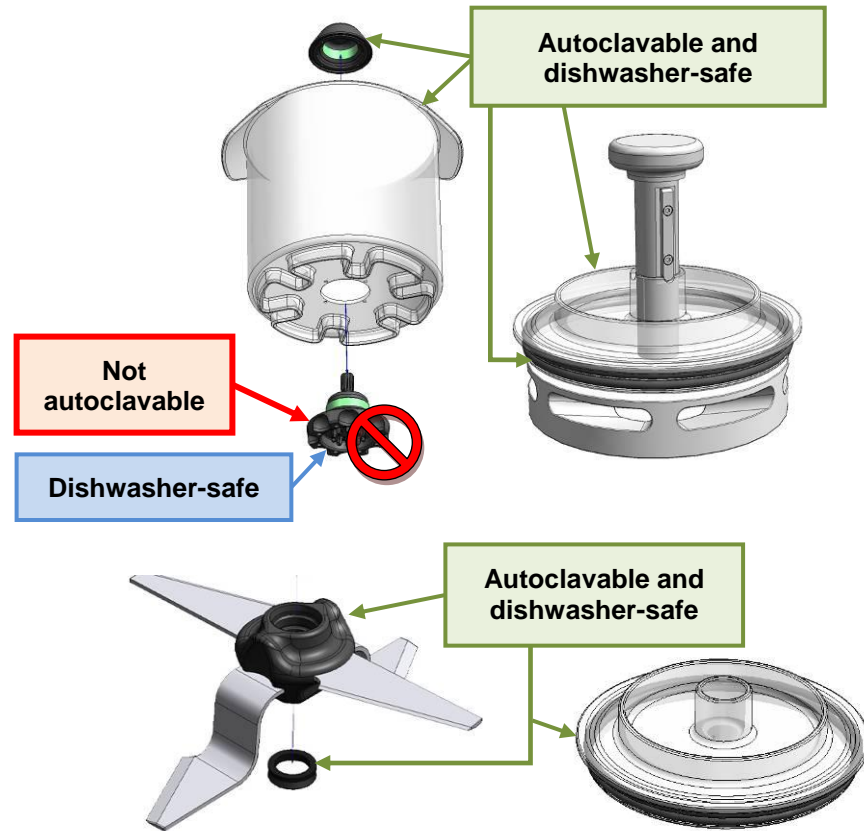

Fig. 17: Autoclavable and dishwasher-safe components and exceptions

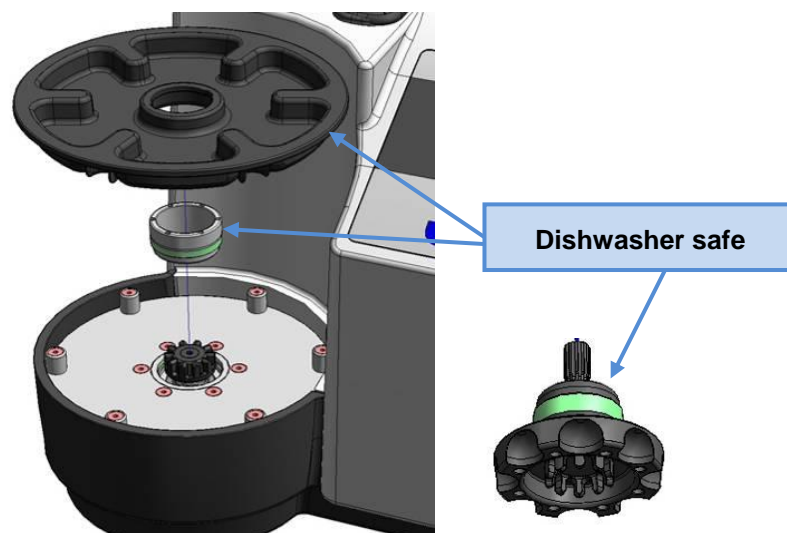
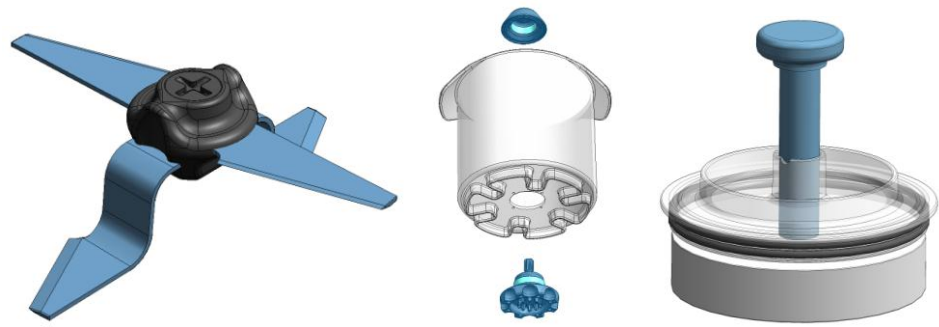

Fig. 18: Dishwasher safe components

NOTICE

- Dry all metallic parts of the grinding jar and the knife after drying to prevent possible corrosion.



Under certain conditions there may be corrosion on metallic parts. This is not a quality defect and can occur despite best material quality.

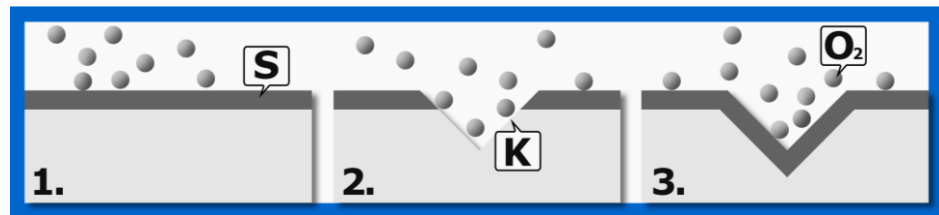

Fig.19: Protective oxide layer

The resistance of “stainless” steel is attributable to an extremely thin invisible protective oxide layer (**S**), the so-called passive layer.

Since the grinding tool surfaces are exposed to mechanical load, small areas of corrosion (**K**) may appear after this protective oxide layer has been damaged.

- This corrosion can be prevented if you dry the grinding tools after rinsing.

In the case of the steel used by Retsch, the protective layer is automatically continuously formed through a reaction with oxygen (**O₂**).

- Should areas of rust develop despite this, they can be removed by vigorous polishing.

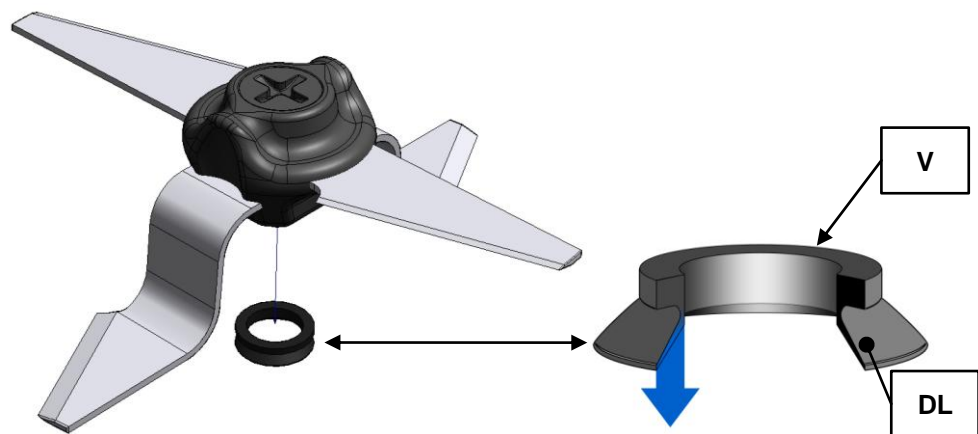

Fig. 20: Ring seal

NOTE

- Check the state of the V-ring seal (**V**) regularly.
- The bottom edge of the lip seal (**DL**) must be clean and smooth.
- Replace the V-ring seal when the lip seal is brittle, cracked, frayed or damaged in order to prevent rust and damage to the cutter bearing.

(V-ring seal part number: **05.111.0243**)

9 Accessories

NOTE

The use of the gravity lid reduces the possible filling capacity of the grinding jar by 5 cm under the edge of the jar. This corresponds to a filling capacity of 3.5 litres.

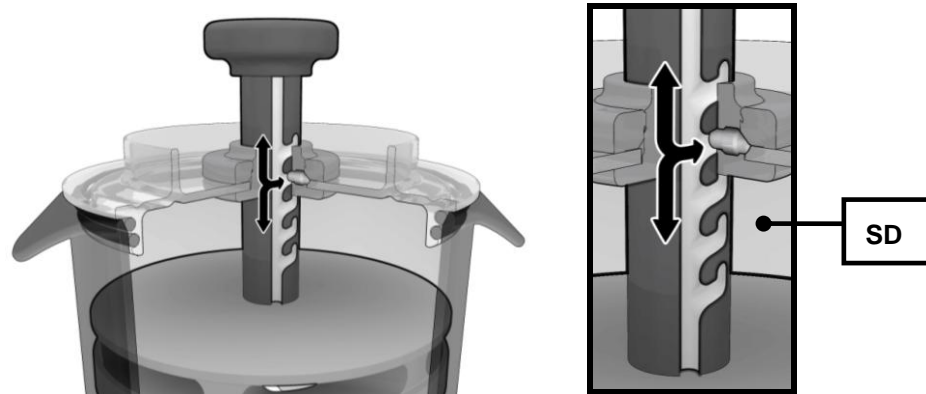

Fig. 21: Engaging the gravity lid in the securing recess

- Pull the handle upwards before inserting the gravity lid.
- Turn the gravity lid to engage the lid (**SD**).
- Put the gravity lid onto the grinding jar.
- Insert the grinding jar with gravity lid into the device.
- Close the flap and start the grinding process.
- Disengage the gravity lid during grinding and let it drop.

Once the mill is started, the required grinding chamber capacity changes due to the circulating effects and centrifugal forces etc. acting on the now liquefied grinding stock. The gravity lid moves as well and in this way constantly optimises the grinding chamber.

However, this works only with products which have a high water content.

10 Disposal

Please observe the respective statutory requirements with respect to disposal.

Information on disposal of electrical and electronic machines in the European Community.

Within the European Community the disposal of electrically operated devices is regulated by national provisions that are based on the EU Directive 2002/96/EC on Waste Electrical and Electronic Equipment (WEEE).

Accordingly, all machines supplied after 13.08.2005 in the business-to-business area to which this product is classified, may no longer be disposed of with municipal or household waste. To document this they have the following label:

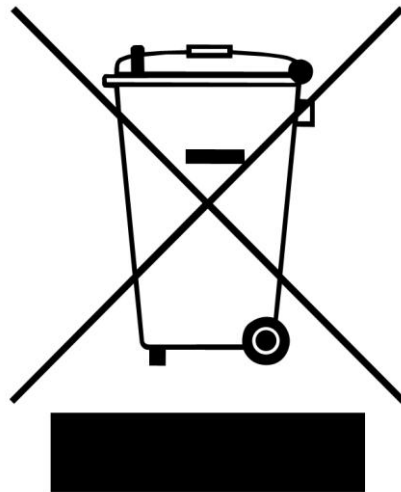

Fig. 22: Disposal label

Since the disposal regulations within the EU may differ from country to country we would request you to consult your supplier.

11 Index

(
(CO ₂)	22
A	
Accessories	34
Amperage	12
Atmospheric humidity	10
Autoclavable components	32
B	
Bar code	12
beating	26, 29
C	
Capacity	12
Cardboard Cross	11
CE marking	12
Changes	5
Cleaning and service	32
Closing the grinding chamber	20
Closure of the housing cover	20
Conditions for the place of installation	10
Confirmation	9
Connection cable	11
Copyright	5
Corrosion	33
cutting	26, 29
D	
Degree of protection	14
Description	19
Detailed views of housing	17
Device designation	12
Dimensions and weight	15
Direction of rotation	26, 29
Dishwasher safe components	32
Disposal	35
Disposal label	12
Disposal label	35
Drive output	15
Dry ice	22
Dusty sample	24
E	
Electrical connection	11
Emergency unlocking	30
Emergency unlocking of flap	30
Emissions	14
End	25
Explanations of the safety warnings	6
External fuse	11
F	
face spanner	23
Fault messages	31
Front view	16
Function	19
Fuse strength	12
Fuse type	12
G	
General safety instructions	7
Graphical view of the Control Panel	18
Gravity lid	34
Grinding jar disassembly	17
Grinding Jar Lid Sealing Rings	24
H	
Handling the Knife	20
Height with Hood Cover Closed	15
Height with Hood Cover Open	15
I	
Inserting the grinding jar	22
Inserting the grinding jar and closing the device	24
Installation height	11
Installation of the machine	11
Interrupting and continuing the grinding process	25
Interrupting the Grinding Process	25

K		Required floor space.....	15
Knife Speed	15	Revmoving the knife – fill level of the grinding jar	21
M		Rotation speed.....	15
Magnetic force	21	rpm.....	15
Mains frequency	12	Runny samples	29
Manufacturer’s address	12	S	
Maximum relative humidity	10	Safety Margins	15
Maximum speed	29	Safety warnings	6
Menu structure	26	Sealing lip	21
Moderate or mild injury	6	Sealing rings	24
motor-driven lid closure	20	Securing recess	34
N		Selection bar	26
Notes on the Operating Manual.....	5	Serial number.....	12
Number of fuses	12	serious injury.....	6
O		Service Address.....	8
Opening and closing of the grinding chamber	20	Setting Possibilities on the Display Menu	26
Operating elements and displays	17	Setting the Direction of Rotation	29
Operating the machine	16	Setting the Direction of Rotation	29
Overview table of the parts of the device	19	Setting the grinding time	28
P		Setting the interval	29
Packaging	10	Setting the minutes	29
Part number	12	Setting the minutes	28
Pause.....	25	Setting the Speed	28
Power version	12	Starting the grinding process	25
Preparing the grinding jar, inserting the knife	22	Stopping the grinding process	25
property damage.....	6	Stopping the Grinding Process	25
Protection for knives during transport.....	11	Switching On and Off.....	20
Protective equipment.....	13	Switching on for the First Time	20
Protective layer	33	T	
R		Target group	7
Rated power	15	Technical data.....	13
Rated voltage.....	15	Temperature fluctuation and condensed water .	10
Rear view	16	Transport.....	10
Recessed grips on the knife	21	Transport, scope of delivery, installation	10
Regulations for the place of installation.....	11	Type plate	11
Removing the transport safeguard	11	type plate description.....	11
Repairs.....	8	Type plate lettering	12

U

Use of the machine for the intended purpose13

V

ventilation properties.....22

View of the back30

Views of the Instrument 16

W

Watery sample 24

Weight..... 15

Working instructions..... 31

Y

Year of production..... 12

LABORATORY KNIFE MILL

GM 300 - GRINDOMIX

Certificate of CE-Conformity according to:

EC Mechanical Engineering Directive 2006/42/EC

Applied harmonized standards, in particular:

DIN EN ISO 12100	Security of machines
DIN EN ISO 12852	Food processors and blenders
DIN EN 954-1	Safety related parts of control systems

EC Directive Electromagnetic Compatibility 2004/108/EC

Applied standards, in particular:

DIN EN 55011 B / Generic standard interference emission - living areas -
DIN EN 61000-3-2; DIN EN 61000-3-3; DIN EN 61326-1; DIN EN 61000-6-2; DIN EN 61000-4-2;
DIN EN 61000-4-3; DIN EN 61000-4-4; DIN EN 61000-4-5; DIN EN 61000-4-6; DIN EN 61000-4-11

Additional applied standards, in particular

DIN EN 61010	Safety prescriptions concerning measuring-, operating-, controlling- and laboratory equipment
--------------	-----------------------------------------------------------------------------------------------

Authorized person for the compilation of technical documents:

J. Bunke (technical documentation)

The following records are held by Retsch GmbH in the form of Technical Documentation:

Detailed records of engineering development, construction plans, study (analysis) of the measures required for conformity assurance, analysis of the residual risks involved and operating instructions in due form according to the approved regulations for preparation of user information data.

The CE-conformity of the Retsch Laboratory Knife Mill GM 300 is assured herewith.

In case of a modification to the machine not previously agreed with us as well as the use of not licensed spare parts and accessories this certificate will lose its validity.

Retsch GmbH

Haan, january 2010

Dr. Stefan Mähler
Manager technical services





Copyright

® Copyright by
Retsch GmbH
Haan, Retsch-Allee 1-5
D-42781 Haan
Federal Republic of Germany