

Findenser™

SUPER air condenser

Patented

Replaces the need for
water-cooled condensers
in over 95% of all
common chemistry
applications

- **Save water**
- **Prevent flooding**



Findenser - minimises risk of flooding in the laboratory

Findenser requires no running water to operate. Water is a precious resource. It makes little economic or environmental sense to waste thousands of litres just to cool a single condenser.

What are the benefits?

- No risk of flooding from running water
- Eliminates water purchase and disposal costs
- For solvent volumes from 5ml up to 1 litre
- Helps meet sustainable water reduction targets

How much is water costing your laboratory?

The cost of running a water condenser	1 tap running at 2.5 litres per minute		
	4 hours	8 hours	24 hours
Water consumption per day (litres)	600	1200	3600
Cost per day	£1	£2	£6
Cost per month, 20 working days	£20	£40	£120
Cost per year	£240	£480	£1,440

Based on a flow of 2.5 litres per minute, at a cost of 0.16p per litre for supply and disposal of water. Price from Veolia Water 2015 commercial pricing.

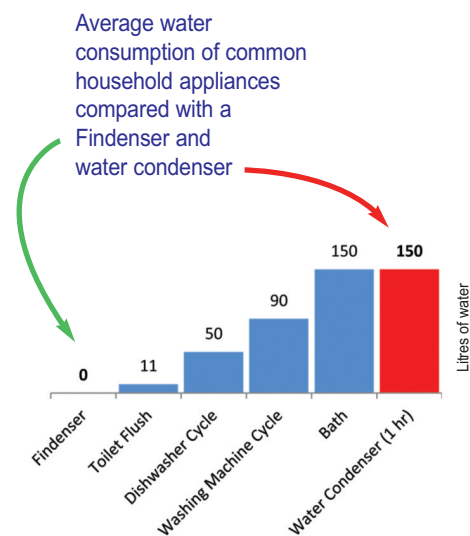

Finned aluminium jacket

- Excellent thermal conductivity
- High performance air-cooling
 - Chemical-resistant anodised surface

Ground glass socket

- Accepts standard tapered cones
- Choice of sizes

Easy clamping

- Use with standard laboratory clamps
 - Clamping kits available

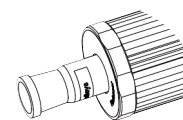

Anti-roll design

- Contoured edges prevent rolling when not in use
- Prevents damage to aluminium fins

Patented design

- Sealed assembly
- Encapsulated thermofluid for maximised thermal conductivity and heat transfer

Choice of flasks

- 10ml to 2 litre flasks
- Maximum solvent volume 1 litre

Ground glass cone

- Fits standard tapered glass sockets
- Choice of sizes

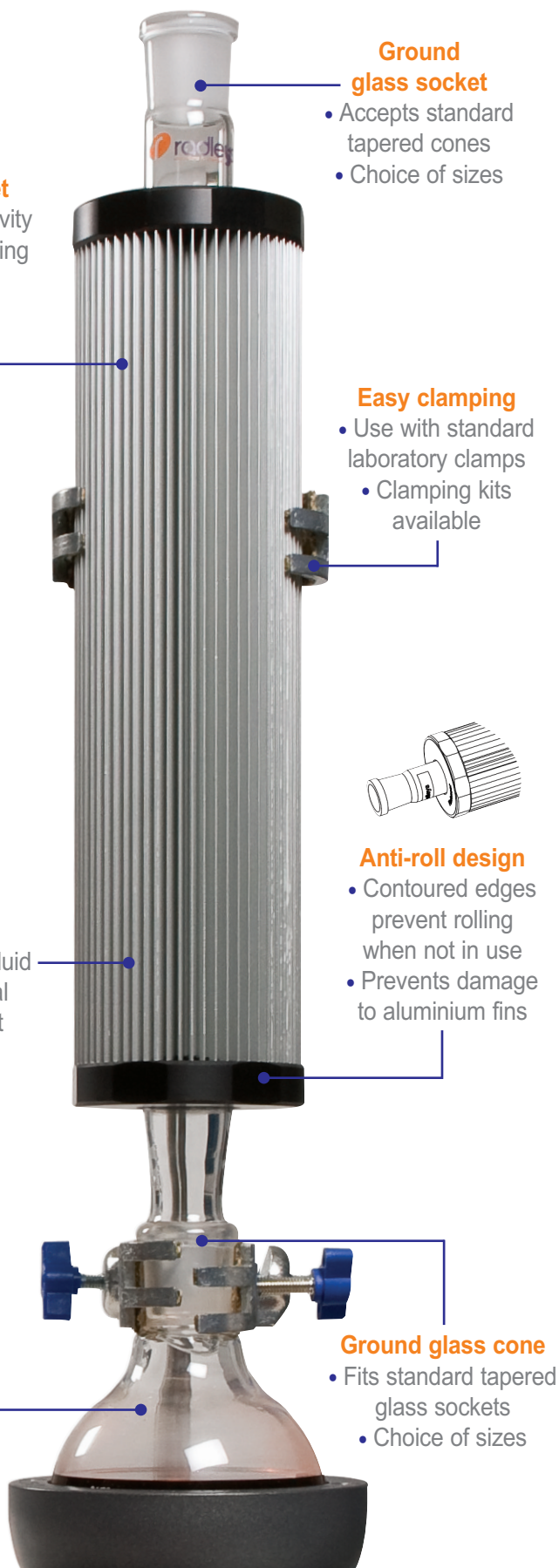

Findenser - performs as well as a water condenser

Findenser replaces water-cooled condensers in over 95% of common chemistry applications

Findenser performance testing

A range of solvents, in identical flasks and set-ups, were tested with a Findenser, water condenser and air condenser to record solvent loss by weight.

Compared with an air condenser

For synthesis with low boiling point solvents, Findenser showed a significant improvement in solvent retention. With acetone or DCM the reaction boiled dry when using an air condenser, yet Findenser retained 95% of the solvent under the same conditions.

For synthesis with medium boiling point solvents, Findenser delivered improved solvent retention particularly with larger volumes and high temperatures.



Compared with a water condenser

Under identical conditions, Findenser retained solvent to the same level (within the limits of experimental error) as a water condenser with a range of solvents. Diethyl ether is not recommended for use with Findenser.

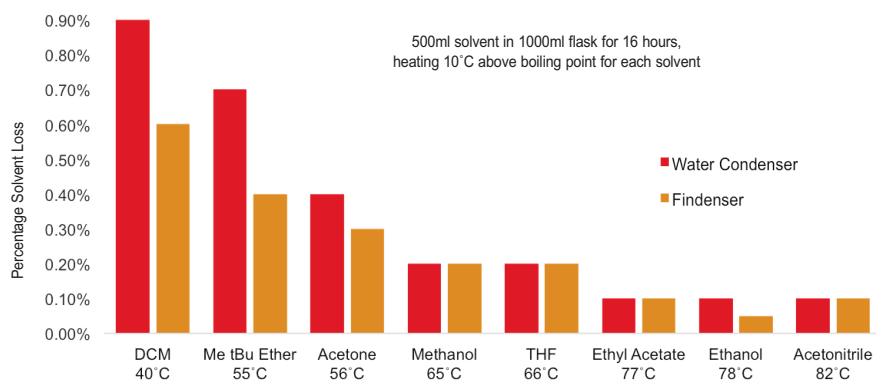

Time to switch

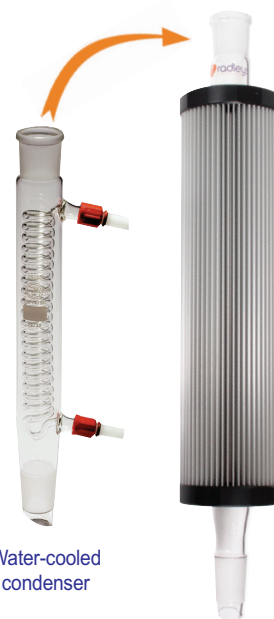

Water-cooled condenser

How does Findenser work?

- Findenser comprises an internal glass condenser and an external, finned aluminium jacket, between which a small amount of water is permanently sealed.
- The glass condenser design has a greater internal surface area than traditional condensers, increasing heat transfer capacity.
- The finned jacket fits around the glass condenser, further increasing the external surface area.
- The result is a 'SUPER air condenser'.

Choice of B14, B19, B24 and B29 joint sizes

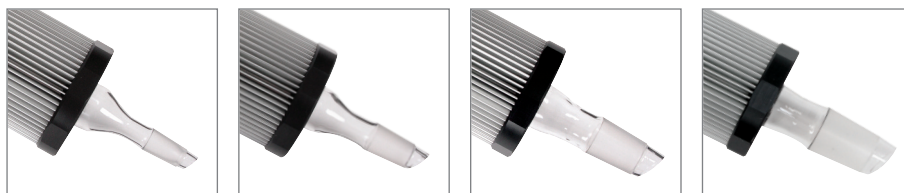

B14

B19

B24

B29

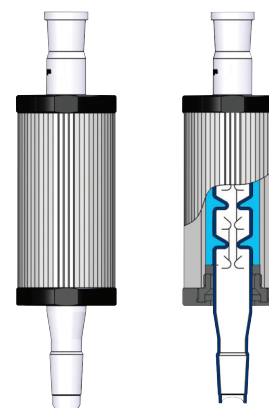

Findenser Mini cross section

Findenser ordering information

Findenser

RR31100	Findenser B24 Cone, B24 Socket - 400mm long
RR31102	Findenser B29 Cone, B24 Socket - 400mm long
RR31104	Findenser B19 Cone, B19 Socket - 400mm long

Findenser Mini

RR31105	Findenser B24 Cone, B24 Socket - 275mm long
RR31107	Findenser B19 Cone, B19 Socket - 275mm long
RR31109	Findenser B14 Cone, B14 Socket - 275mm long



Accessories

RR31200	PTFE Adapter B24 Socket to B29 Cone
RR31202	PTFE Adapter B19 Socket to B24 Cone
RR31204	PTFE Adapter B19 Socket to B29 Cone
RR31206	PTFE Adapter B14 Socket to B19 Cone
RR31208	PTFE Adapter B14 Socket to B24 Cone
RR139139	Right Angle Adapter Ordinary B24 + GL14 + fittings
RR139140	Right Angle Adapter Ordinary B19 + GL14 + fittings
RR139141	Right Angle Adapter Ordinary B14 + GL14 + fittings
RR139142	Enlarging Adapter Ordinary B24 to B29

Clamps and Accessories

RR31210	Retort Stand, 2 Position Base + 12x750mm SS Rod
RR31212	Retort Stand, 2 Position Base
RR31214	Support Rod SS 12x600mm No Thread
RR31216	Support Rod SS 12x750mm No Thread
RR31218	Support Rod SS 12x1000mm No Thread
RR71110	Retort Clamp to 85mm
RR71115	Boss Head to 16mm
RR71120	Support Rod Hotplate Adapter (extension plate)
RR71125	Support Rod SS 13x340mm M10
RR71127	Support Rod SS 13x500mm M10

Rod and Clamp Kits

RR71510	Rod and Clamp Kit for Carousel Hotplate 1 x RR71120 - Support Rod Hotplate Adapter 1 x RR71127 - Support Rod SS 13x500mm M10 1 x RR71110 - Retort Clamp to 85mm 1 x RR71115 - Boss Head to 16mm
RR71516	Rod and 2 x Clamp Kit for Carousel Hotplate 1 x RR71120 - Support Rod Hotplate Adapter 1 x RR71127 - Support Rod SS 13x500mm M10 2 x RR71110 - Retort Clamp to 85mm 2 x RR71115 - Boss Head to 16mm
RR71512	Stand, Rod and Clamp Kit 1 x RR31210 - Retort Stand, 2 Position Base and 12x750mm SS Rod 1 x RR71110 - Retort Clamp to 85mm 1 x RR71115 - Boss Head to 16mm
RR71514	Stand, Rod and 2 x Clamp Kit 1 x RR31210 - Retort Stand, 2 Position Base and 12x750mm SS Rod 2 x RR71110 - Retort Clamp to 85mm 2 x RR71115 - Boss Head to 16mm



We recommend that both Findenser and your flask are securely clamped.

Technical Specifications

Length x Diameter	275mm x 72mm / 400mm x 72mm
Joints	B14, B19, B24 & B29
Weight	670g / 1200g
Inner or wetted parts	Borosilicate glass
Finned jacket	Anodised aluminium
Plug and Seal	Acetal and HT silicone
Thermofluid	Water
Max solvent bpt	155°C
Oven drying	Max temp. 60°C
Dishwasher	Max temp. 50°C
Autoclaving	Do not autoclave
Operating temp. range	0°C to 60°C



RR71510 Rod and Clamp Kit for Carousel Hotplate



RR71516 Rod and 2 x Clamp Kit for Carousel Hotplate



RR71125 Support Rod SS 13x340mm M10
RR71127 Support Rod SS 13x500mm M10



RR71120 Support Rod Hotplate Adapter



RR71512 Stand, Rod and Clamp Kit



RR71514 Stand, Rod and 2 x Clamp Kit



RR31210 Retort Stand, 2 Position Base + 12x750mm SS Rod



RR31212 Retort Stand, 2 Position Base



RR31214 Support Rod SS 12x600mm No Thread
RR31216 Support Rod SS 12x750mm No Thread
RR31218 Support Rod SS 12x1000mm No Thread



RR71110 Retort Clamp to 85mm



RR71115 Boss Head to 16mm



RR139139/140 Right Angle Adapters



RR31200 PTFE Adapter B24 Socket to B29 Cone